

## ADJUSTMENT RANGE

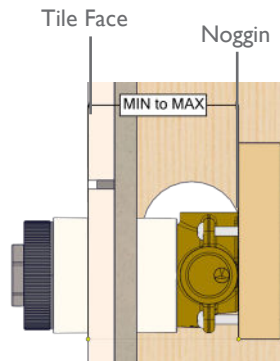

MIN: 68mm  
 MAX: 80mm

**1**

Mount the Mixer Body in place using the screws provided.

Ensure that Mixer Body is level.

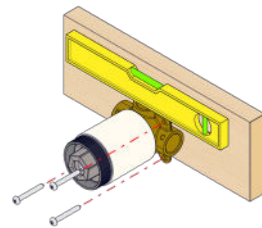

**2**

Remove Plastic Locknut. Apply Grease to Cartridge O-Rings and install Cartridge.

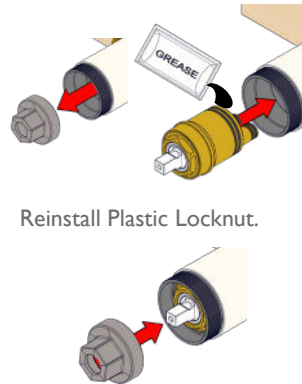

Reinstall Plastic Locknut.

**3**

Connect water supply and water outlet. Test and check for leaks.

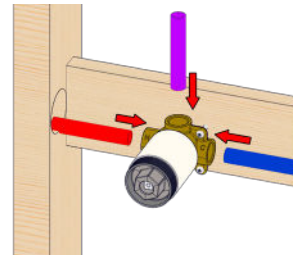

**3**

Seal waterproofing membrane up to waterproofing sleeve.

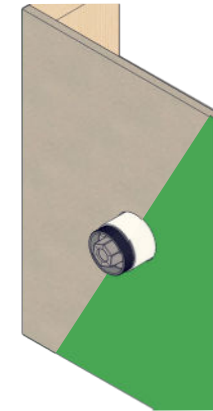

**4**

Use knife to trim Waterproofing Sleeves until flush with tile face.

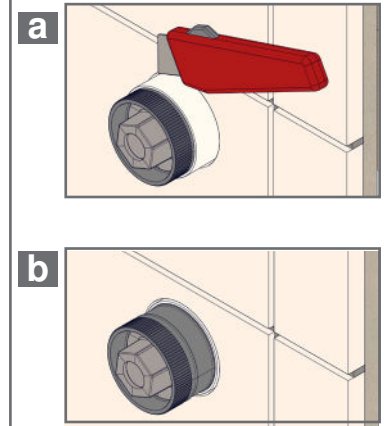

## HOLE DIMENSIONS

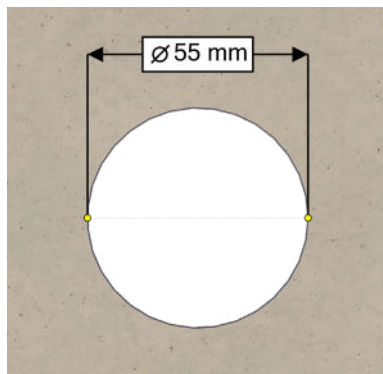

**5**

Unscrew protective cover locknut from Rough In Body.

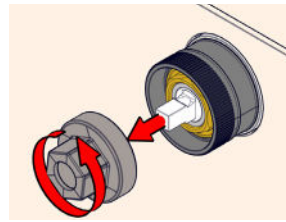

Unscrew Cartridge protective cover.

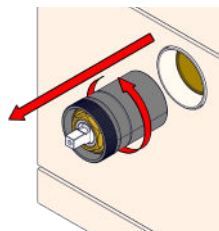

**6**

Screw Wall Mixer Flange onto Rough In Body.

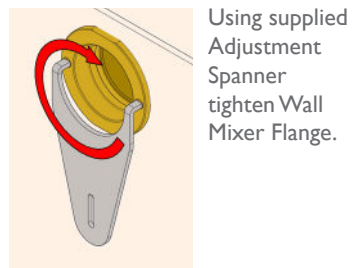
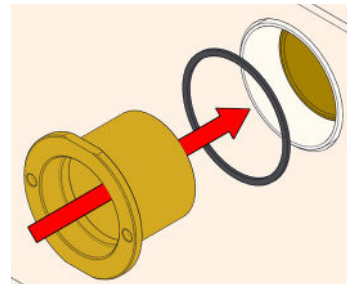

Using supplied Adjustment Spanner tighten Wall Mixer Flange.

**7**

Apply supplied grease to Rubber O-Rings. Slide Cartridge into position.

Tighten Cartridge Locknut into Wall Mixer Flange.

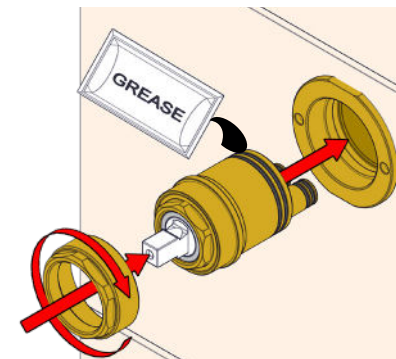

**8**

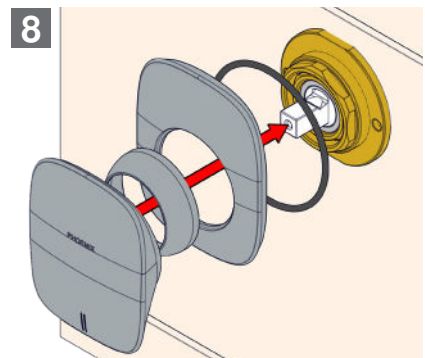

Push Dress plate onto Cartridge and tighten Mixer Dome into place.

Fix Handle into position.

Tighten Grub Screw.

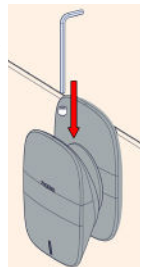

recommended working pressure

**150-500KPa**

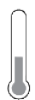

maximum hot water temperature

**75 degrees**

### NOTE:

- If the pressure exceeds or is likely to exceed 550kpa, an approved pressure limiting device must be installed.
- Flush out all pipe work prior to installation.
- If the water temperature exceeds 75°C, an approved tempering valve must be fitted.
- Installation should comply with Australian standard AS3500.1 or relevant local authority requirements. Showers may not be suitable for use within:
  - Gravity-fed water systems
  - Some instantaneous hot water systems; or

### • Pressure supply less than 150kPa;

NOTE: The 500kPa maximum water supply pressure does not apply to fire service outlets.

Failure to comply with the above may void all warranties.

### WARRANTY:

Please refer to the full warranty statement enclosed with the product before installing.

### MAINTENANCE AND CARE:

- Chrome plated surfaces should be cleaned with mild liquid detergent or soap and water.
- Do not use cream cleaners or citrus based cleaning products, as they are abrasive.
- Use of unsuitable cleaning agents may damage the surface. Any damage caused in this way will not be covered by warranty.

### DISCLAIMER:

While we aim to ensure the specifications shown are correct at the time of printing, we reserve the right to make modifications without prior notice. Always use the physical product measurements for mark-ups and roughing-in as the line drawing shown may differ from the actual product over time.

\*All measurements are shown in millimeters.